



METALLO



LAMINATO



FENIX



IMPIALLACCIATO

UNIVERS LAMINATO, FENIX E IMPIALLACCIATO

TAVOLO / TABLE

TAVOLO "UNIVERS" ALLUNGABILE
 STRUTTURA: TRAVERSE IN METALLO E GAMBE IN MDF VERNICIATI
 PIANO SP.2,2 LAMINATO, FENIX E IMPIALLACCIATO

"UNIVERS" EXTENDIBLE TABLE
 FRAME: METAL CROSSPIECES AND PAINTED MDF LEGS
 2.2 TH. LAMINATE, FENIX AND VENEERED TOP

130 X 90 H 77 N.2 PROLUNGHE DA 50

130 X 90 H 77 N.2 EXTENSIONS CM 50

160 X 90 H 77 N.2 PROLUNGHE DA 50

160 X 90 H 77 N.2 EXTENSIONS CM 50

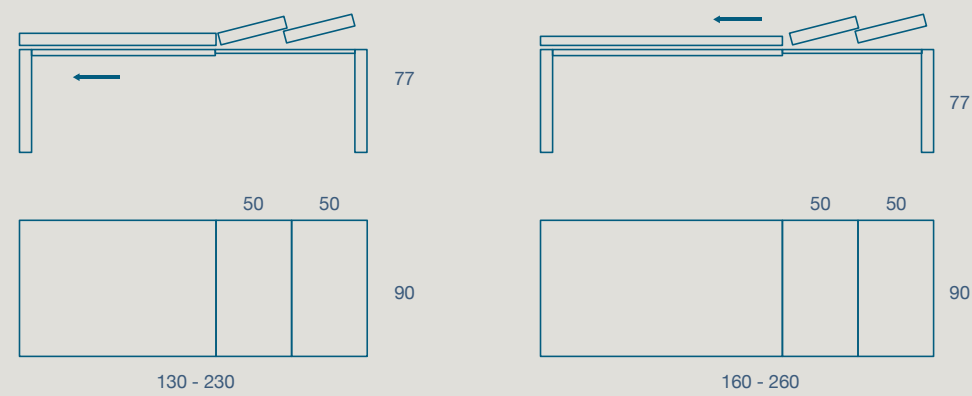







SEDIA LAPEL
 LAPEL CHAIR



FINITURE STRUTTURA (TRAVERSE IN METALLO E GAMBE IN MDF VERNICIATI)

STRUCTURE FINISHES (METAL CROSSPIECES AND PAINTED MDF LEGS)

	bianco assoluto (opz. 740) <i>absolute white</i>		nero (opz. NE) <i>black</i>
	silver dark (opz. 9507) <i>silver dark</i>		grigio kenia (opz. 9501) <i>kenya grey</i>
	grigio selce (opz. 9550) <i>flint gray</i>		ghisa (opz. 9509) <i>cast iron</i>
	argilla (opz.9503) <i>clay grey</i>		

CODICE / CODE	DESCRIZIONE / DESCRIPTION
08UV13L	Laminato/Fenix 130 x 90 Allungabile 230 H 77 / <i>Laminate/Fenix 130 x 90 Extendable 230 H 77</i>
08UV16L	Laminato/Fenix 160 x 90 Allungabile 260 H 77 / <i>Laminate/Fenix 160 x 90 Extendable 260 H 77</i>

CODICE / CODE	DESCRIZIONE / DESCRIPTION
08UV13W	Impiallacciato 130 x 90 Allungabile 230 H 77 / <i>Veneered 130 x 90 Extendable 230 H 77</i>
08UV16W	Impiallacciato 160 x 90 Allungabile 260 H 77 / <i>Veneered 160 x 90 Extendable 260 H 77</i>

FINITURE PIANO LAMINATO PAG. 340

LAMINATE TOP FINISHES

FINITURE PIANO FENIX PAG. 348

FENIX TOP FINISHES

FINITURE PIANO IMPIALLACCIATO

VENEERED TOP FINISHES

 **CLOVER** PAG. 352
CREATIVA PAG. 352
LUNA PAG. 353

 **CONTEMPO** PAG. 355



METALLO



VETRO

UNIVERS VETRO

TAVOLO / TABLE

TAVOLO "UNIVERS" ALLUNGABILE CON PROLUNGHE IN MDF LACCATE COME STRUTTURA
 STRUTTURA: TRAVERSE IN METALLO E GAMBE IN MDF VERNICIATI
 PIANO SP. 1 VETRO TEMPERATO, PIANO SP.1,2 CERAMICO CON SUPPORTO IN VETRO

"UNIVERS" EXTENDIBLE TABLE WITH MDF EXTENSIONS LACQUERED AS THE FRAME
 FRAME: METAL CROSSPIECES AND PAINTED MDF LEGS
 1 TH. TEMPERED GLASS TOP, 12 TH. CERAMIC TOP WITH GLASS SUPPORT

130 X 90 H 77 N.2 PROLUNGHE DA 50

130 X 90 H 77 N.2 EXTENSIONS CM 50

160 X 90 H 77 N.2 PROLUNGHE DA 50

160 X 90 H 77 N.2 EXTENSIONS CM 50

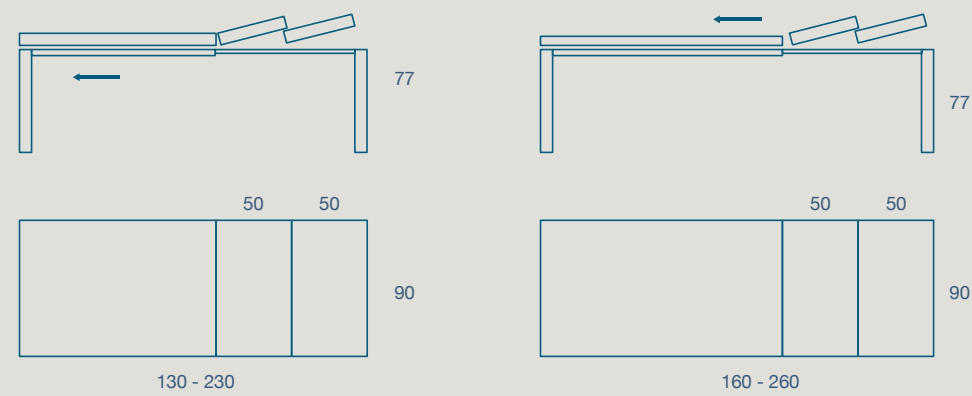

SEDIA LAPEL
 LAPEL CHAIR



METALLO









VETRO



CERAMICO

FINITURE PIANO VETRO OPACO

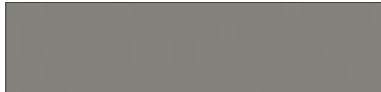
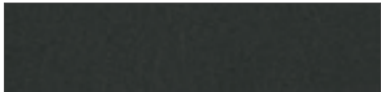





MATT GLASS TOP FINISHES

	bianco assoluto (opz. 740) <i>absolute white</i>		nero (opz. NE) <i>black</i>
	silver dark (opz. 9507) <i>silver dark</i>		grigio kenia (opz. 9501) <i>kenya grey</i>
	grigio selce (opz. 9550) <i>flint gray</i>		ghisa (opz. 9509) <i>cast iron</i>
	argilla (opz.9503) <i>clay</i>		



FINITURE STRUTTURA (TRAVERSE IN METALLO E GAMBE IN MDF VERNICIATI)

STRUCTURE FINISHES (METAL CROSSPIECES AND PAINTED MDF LEGS)

	bianco assoluto (opz. 740) <i>absolute white</i>		nero (opz. NE) <i>black</i>
	silver dark (opz. 9507) <i>silver dark</i>		grigio kenia (opz. 9501) <i>kenya grey</i>
	grigio selce (opz. 9550) <i>flint gray</i>		ghisa (opz. 9509) <i>cast iron</i>
	argilla (opz.9503) <i>clay grey</i>		

CODICE / CODE	DESCRIZIONE / DESCRIPTION
08UV13V	Vetro 130x90 Allungabile 230 H 77 / Glass 130x90 Extendable 230 H 77
08UV16V	Vetro 160x90 Allungabile 260 H 77 / Glass 160x90 Extendable 260 H 77